

Infocommunication

Digital baseband modulation

- Bálint TÓTH, BME TMIT -



M Ű E G Y E T E M 1 7 8 2

Overview

- PPT is for demonstration, not for learning!
- Goal of digital baseband modulation
- Basic types of digital baseband modulation
- Pulse Amplitude Modulation (PAM)
- Inter-Symbol Interference (ISI)
- Additive noise

Digital baseband signal

- Transmission

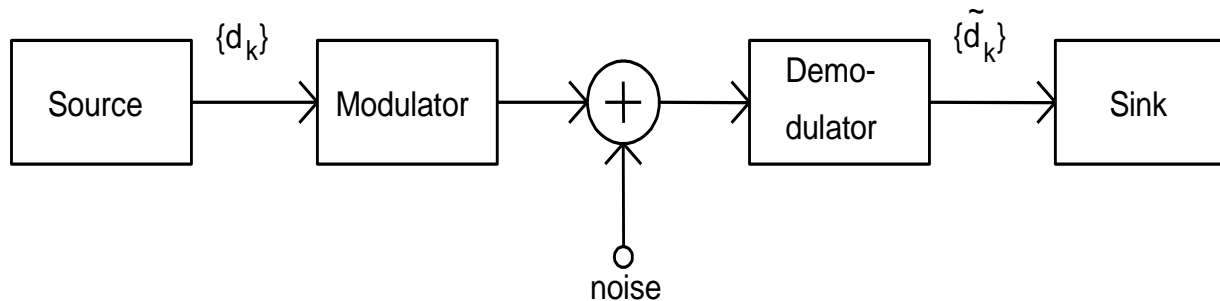

- Channel: analog, LP characteristics
- Source: bits or symbols
- Goal:
 - High bps / baud
 - Low bit error / symbol error

Signal distortion

- What is sent

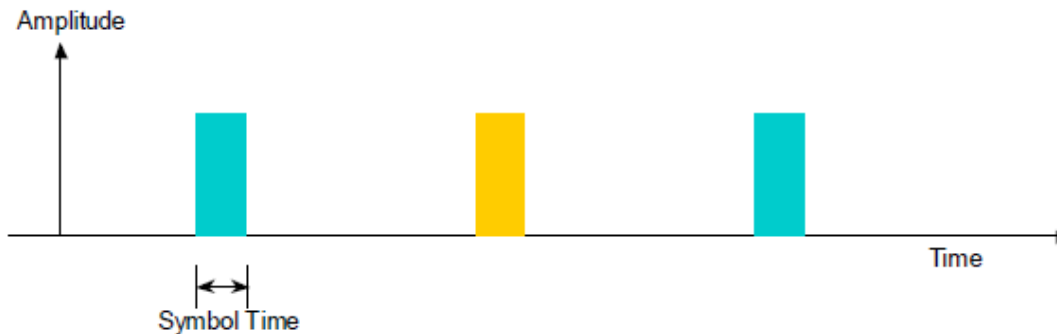

- What is received

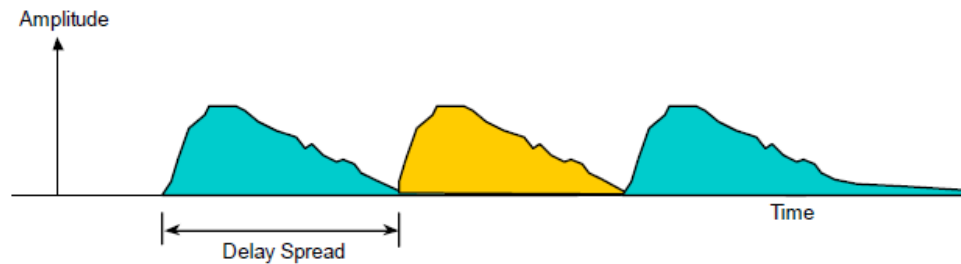

PAM signal distortion 1/4

- What is sent

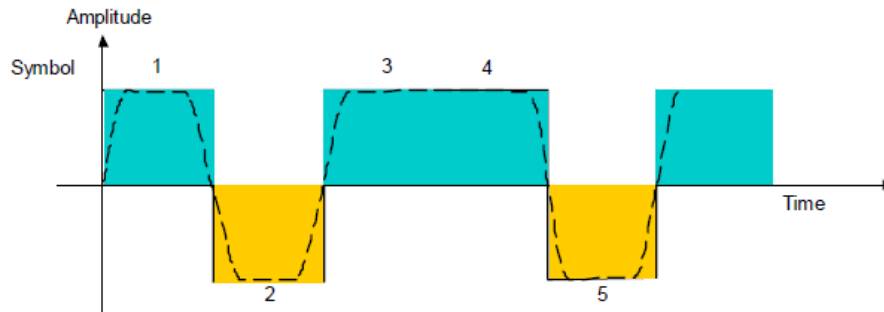

- What is received

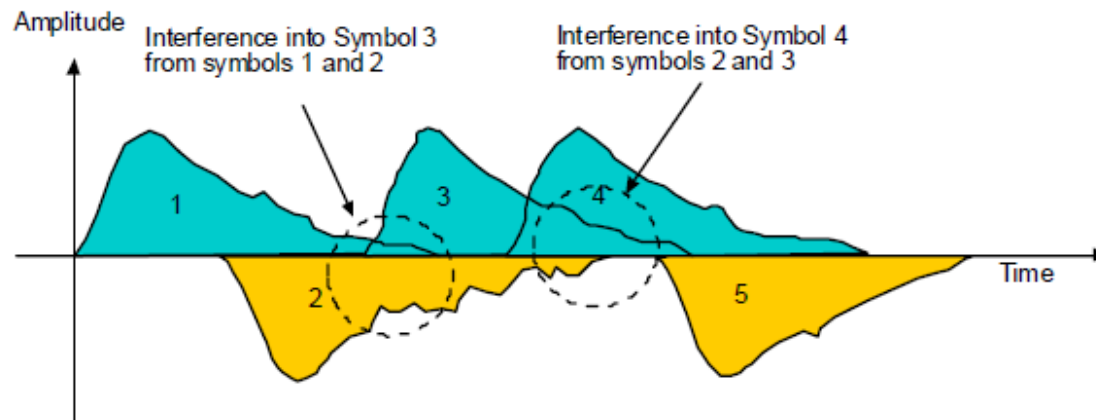

PAM signal distortion 2/4

- Sent and received signals

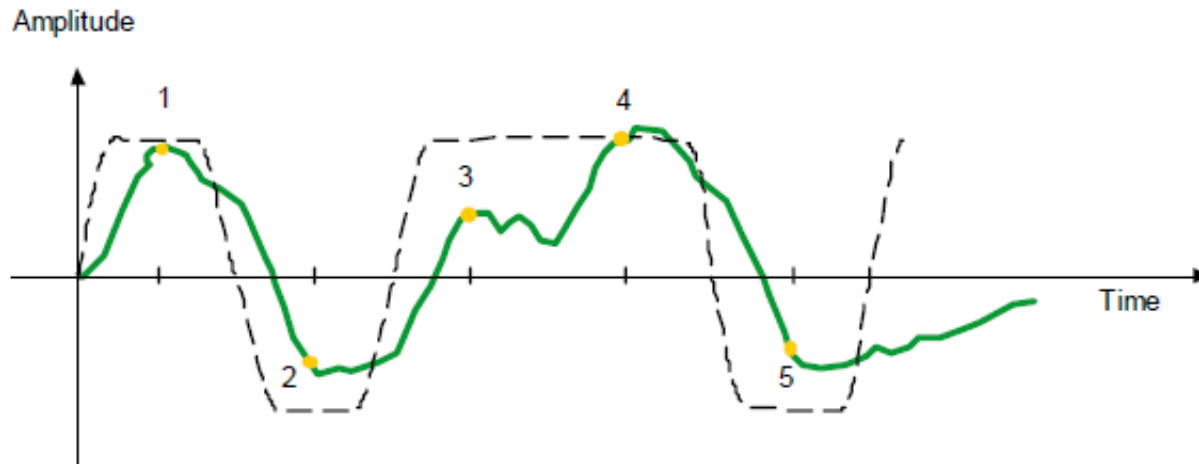

PAM signal distortion 3/4

- We care about what the values are at the sampling points! The rest doesn't matter.

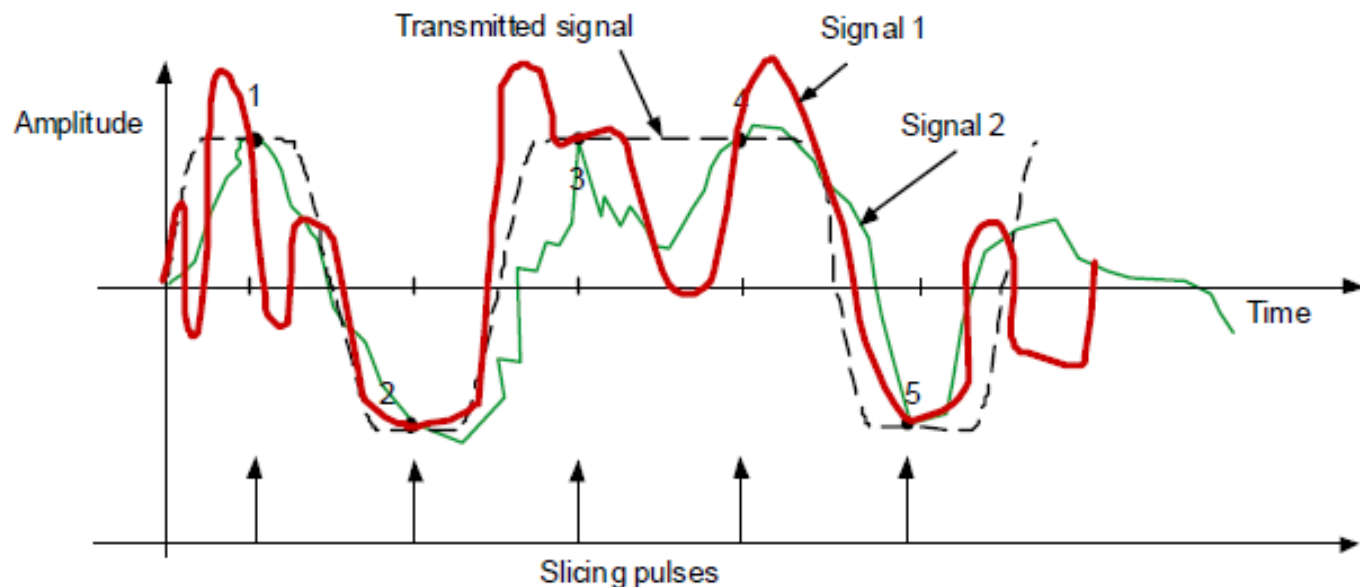

PAM signal distortion 4/4

- Sending 1011.

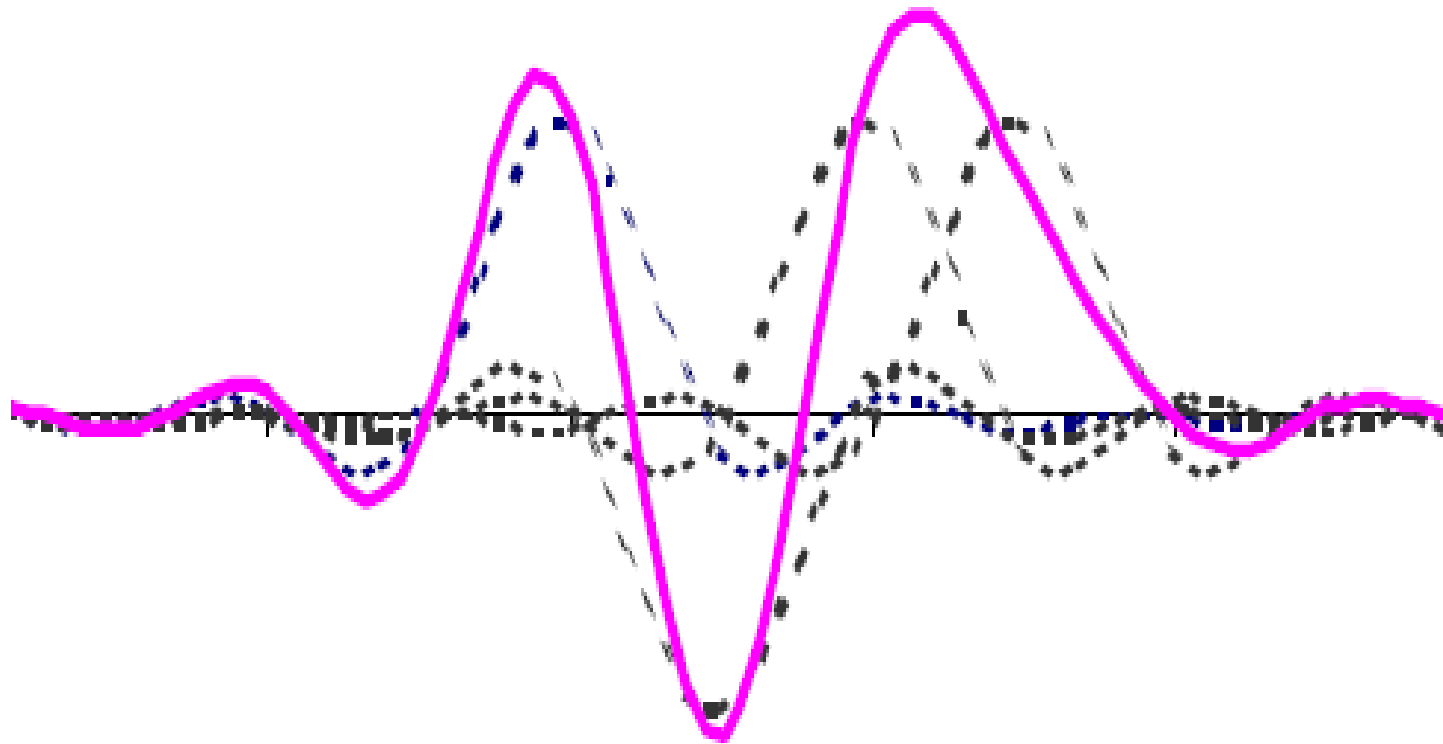

Raised cosine function in frequency domain

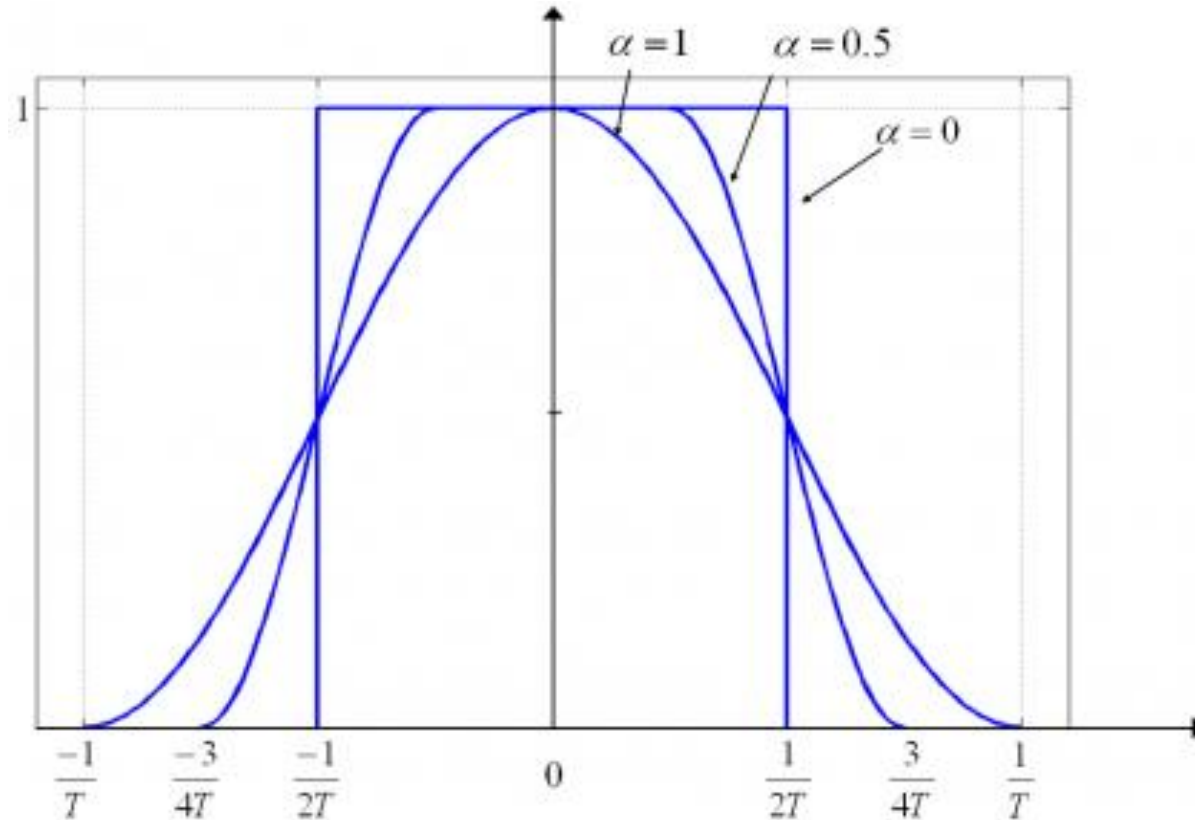

Raised cosine function in time domain

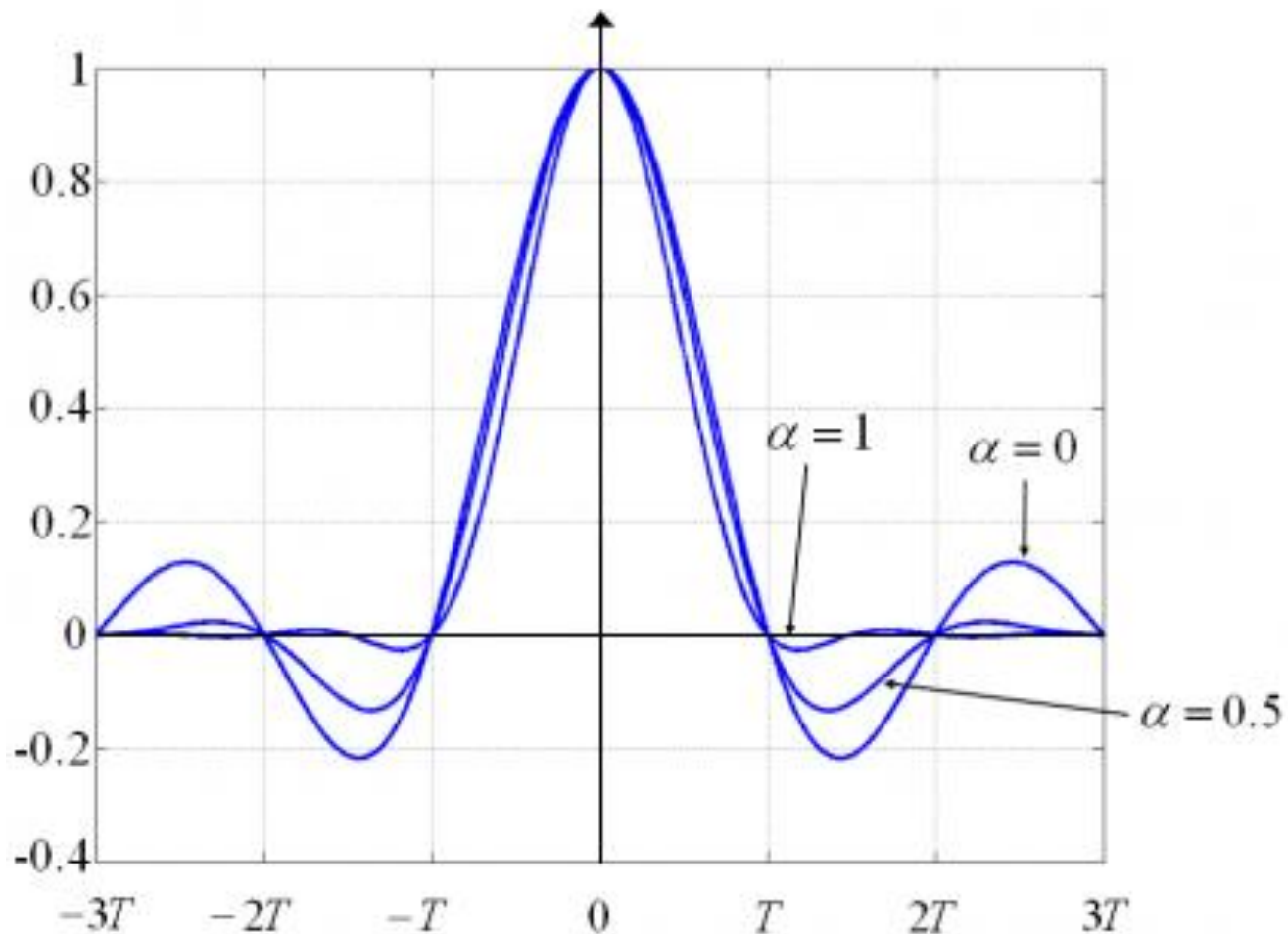

Eye pattern

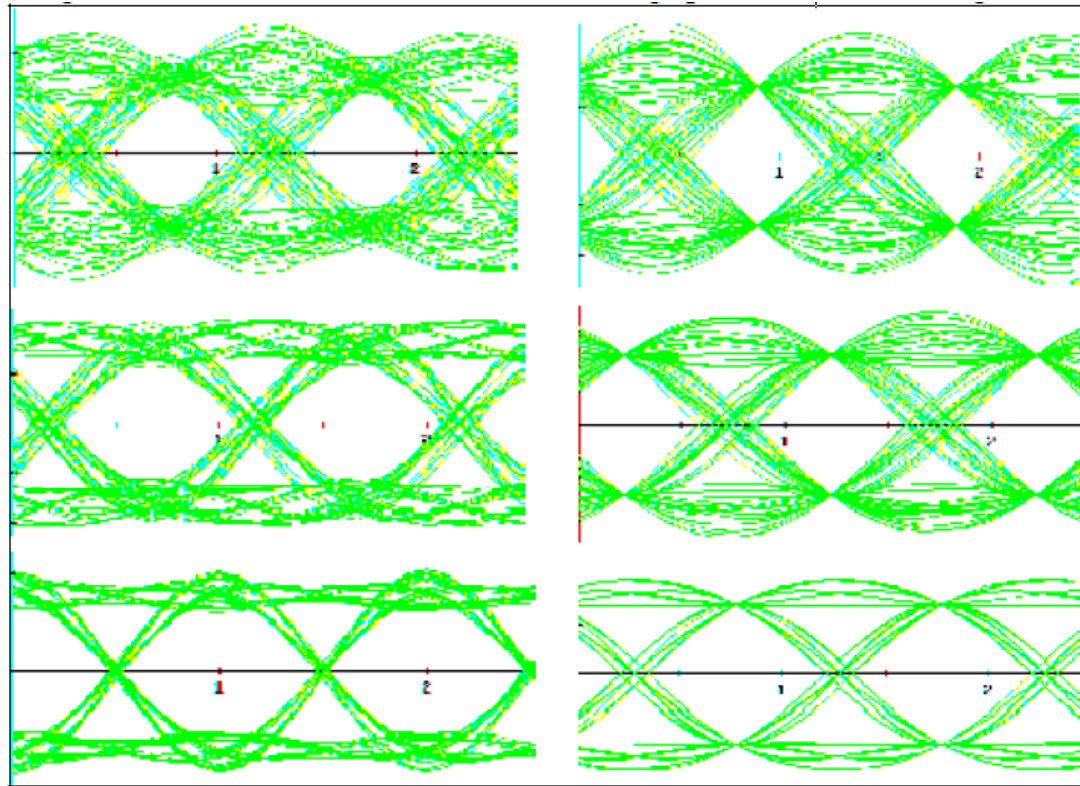

Raised cosine pulses out of transmitter, $\alpha=0.2, 0.4, 0.6$

Raised cosine pulses out of receiver, $\alpha=0.2, 0.4, 0.6$